

GAMES PEOPLE PLAY:
THE BASIC HANDBOOK OF TRANSACTIONAL ANALYSIS

BY ERIC BERNE

Figure 1

(a) A Structural Diagram (b) Simplified Form

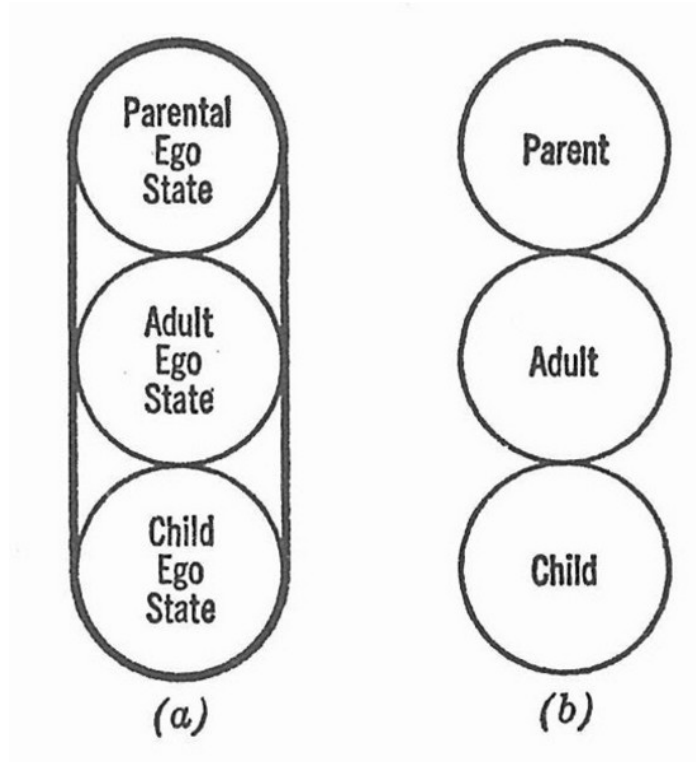

Figure 2
Complementary Transactions

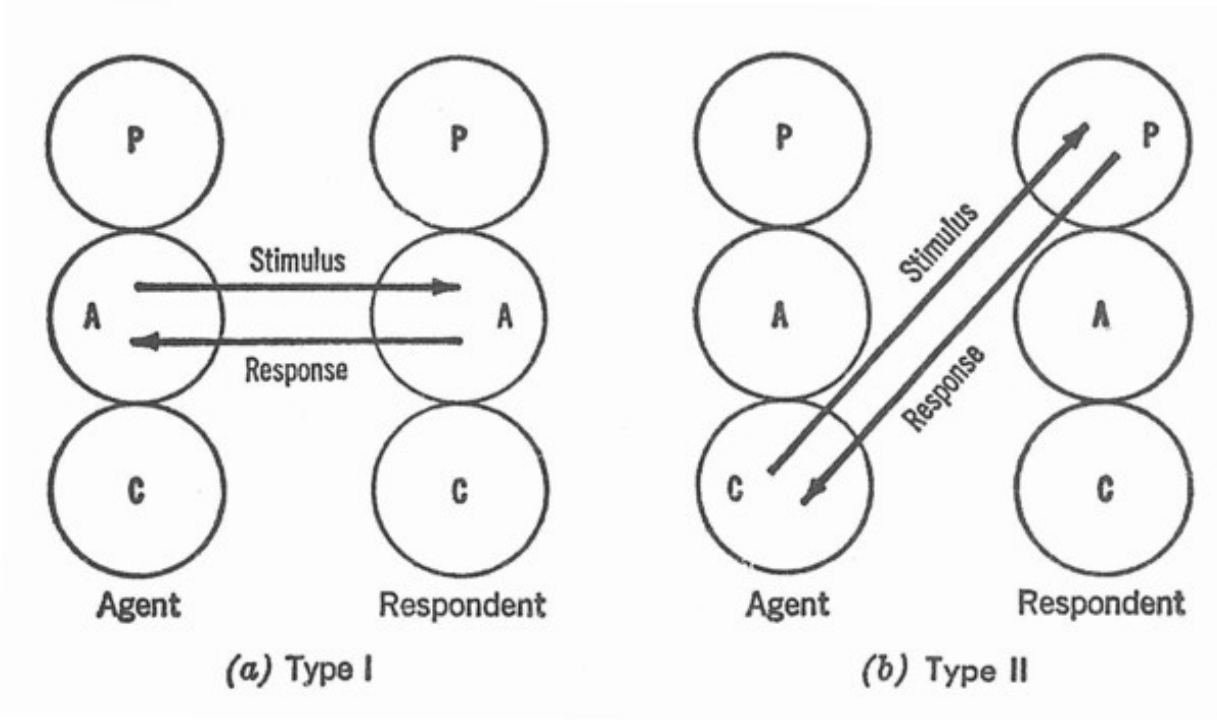

Figure 3
Crossed Transactions

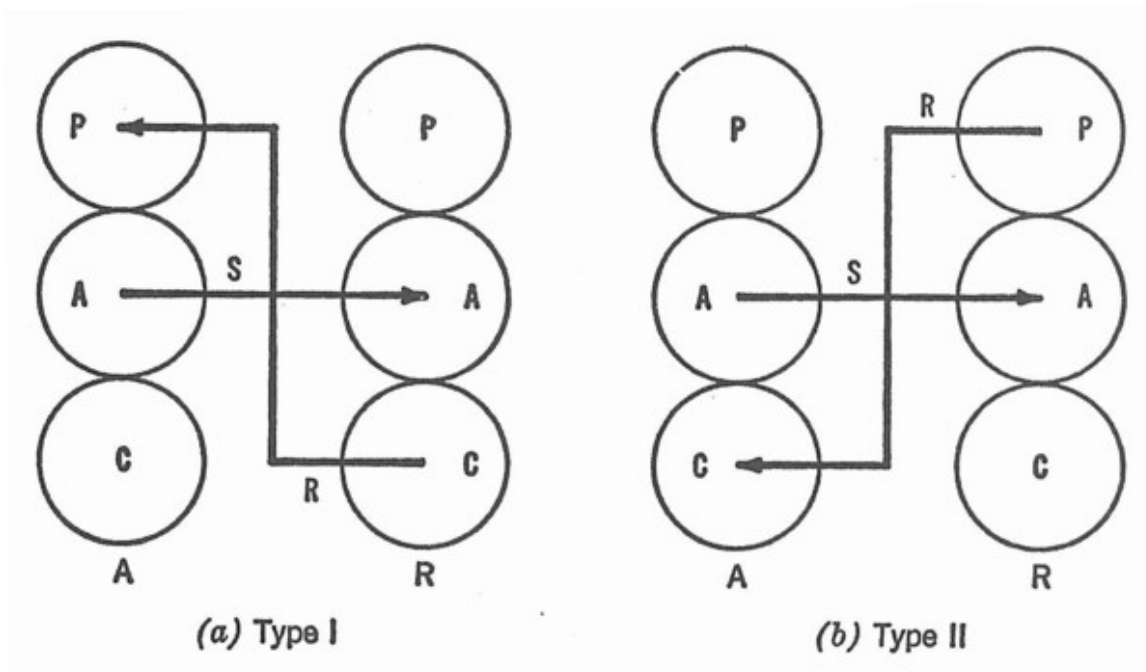

Figure 4
A Relationship Diagram

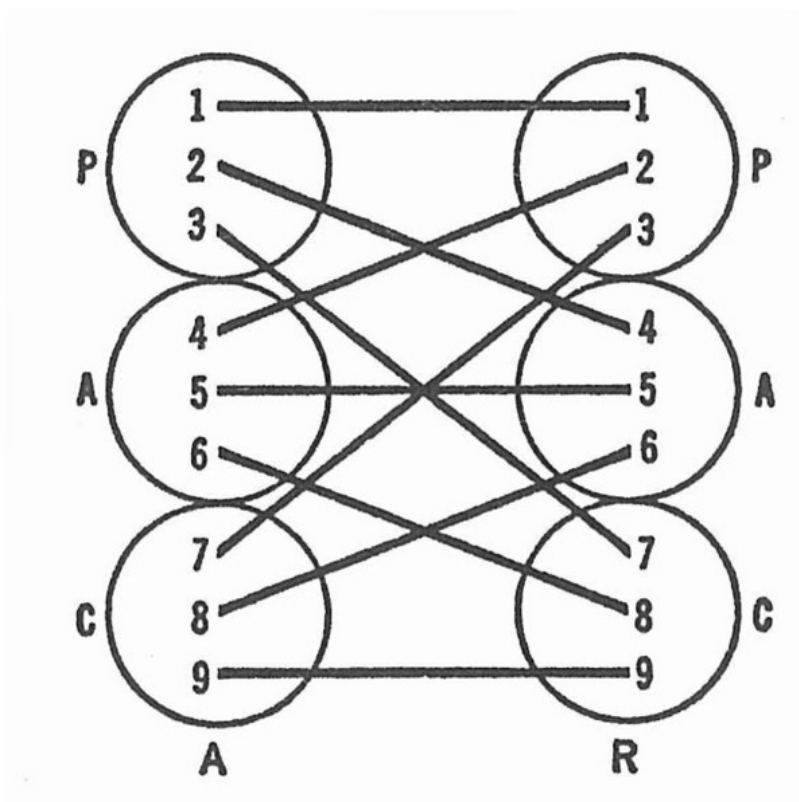
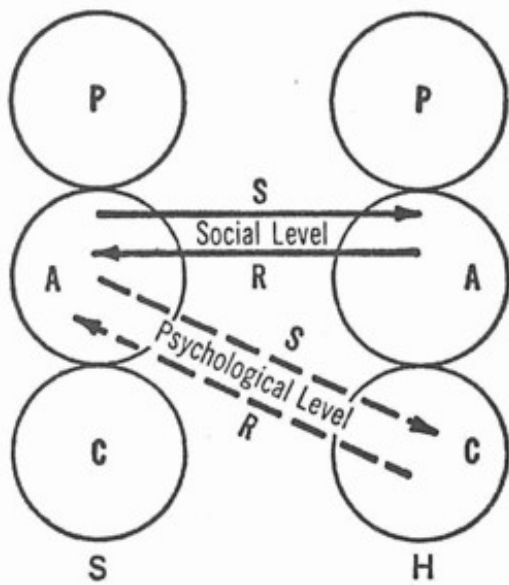
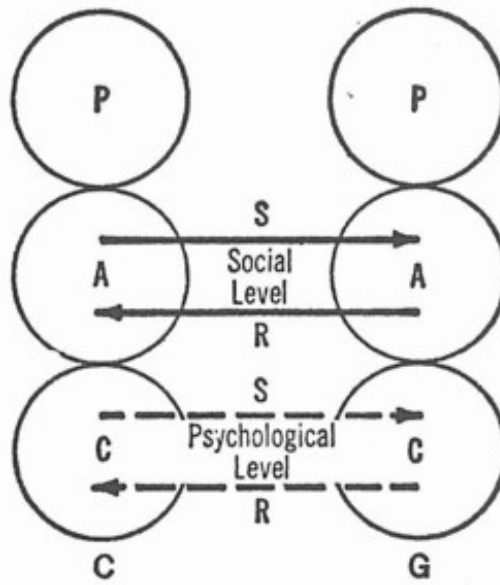

Figure 5
Ulterior Transactions



(a) An Angular Transaction



(b) A Duplex Transaction

Figure 6
Pastimes

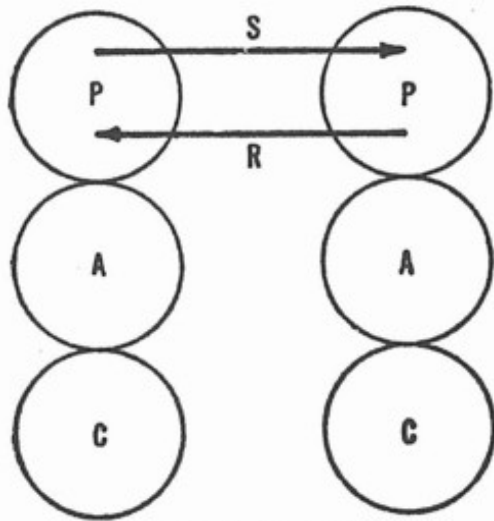

(a) Projective "PTA"
"Juvenile Delinquency"

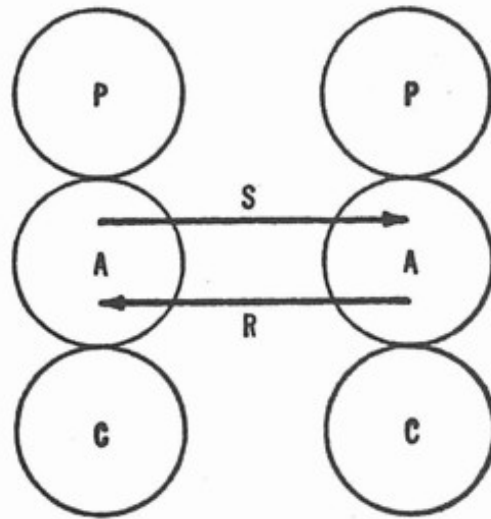

(b) Introjective "Psychiatry"
"Psychoanalysis"

Figure 7
If It Weren't For You: A Game

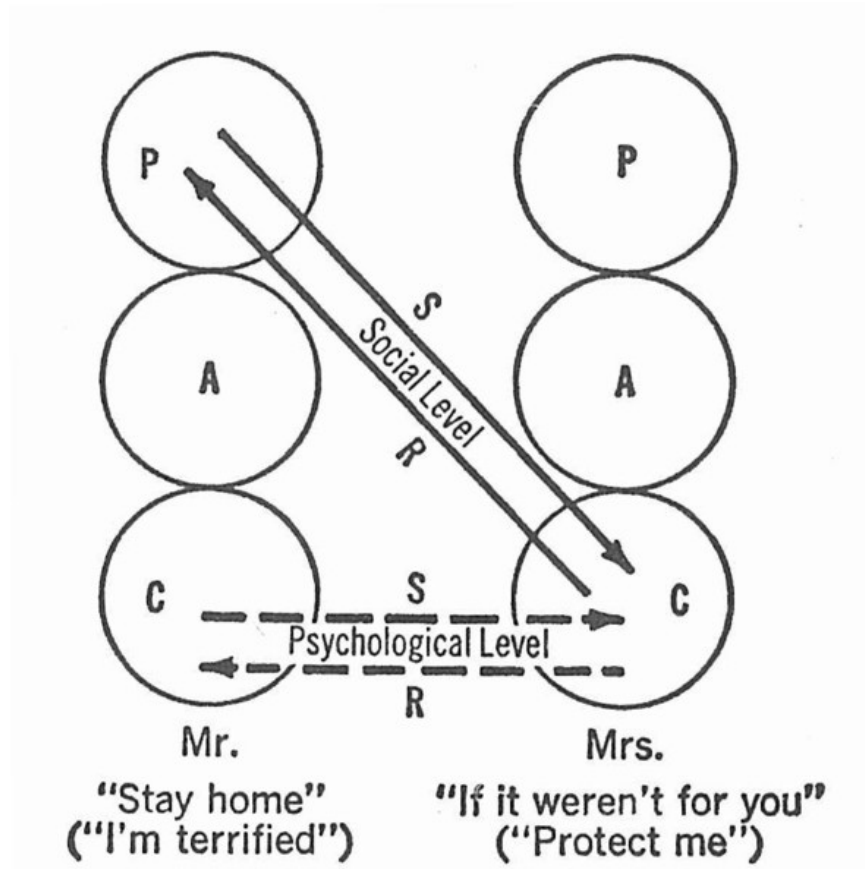

Figure 8
Why Don't You—Yes But

